



www.isdvectis.pl



vectis

vectis

isd

MADE IN POLAND

vectis

Minimalistic shape and color of frames which are made of solid aluminum, with white or black matt surface. The monolithic panel is lightened by a gentle toggle that refers to historical switches. Fits perfectly into every type of interior design.

Minimalistyczny design, doskonale wpisujący się praktycznie w każdą aranżację wnętrza. Ramki wykonane z aluminium, malowane w drobnoziarnistej lub szcztokowanej strukturze. Monolityczny panel rozjaśnia subtelna dźwigenka, która nawiązuje do historycznych przełączników.





OUTSTANDING DESIGN
WYRÓŻNIAJĄCY SIĘ WYGLĄD



6 STANDARD COLOURS OF FRAMES
AND 5 COLOURS OF TOGGLES
6 STANDARDOWYCH KOLORÓW RAMEK
ORAZ 5 KOLORÓW DŹWIGIENEK



OVER FOUR HUNDRED
FRAME CONFIGURATIONS
PONAD CZTERYSTA KONFIGURACJI RAMEK



13 THOUSAND COMBINATIONS
13 TYSIĘCY KOMBINACJI



FROM SINGLE UP TO FIVEFOLD
IN HORIZONTAL OR
VERTICAL ORIENTATION
OD POJEDYNCZYCH DO PIĘCIOKROTNYCH
W POZIOMEJ LUB PIONOWEJ ORIENTACJI



CUSTOM MADE CONFIGURATIONS
AND COLOURS
RAMKI WYKONYWANE NA ZAMÓWIENIE





Over four hundred configurations are available as a standard. From single up to fivehold in horizontal or vertical orientation.

Toggles are made of aluminium, available in 5 colours - black, white, chrome (silver) gold and patina (old gold). Sockets available in two colours - black and white.

Seryjnie dostępne jest ponad czterysta konfiguracji ramek. Od pojedynczych po pięciokrotne w orientacji poziomej i pionowej.

Dźwigienki wykonane są z aluminium. Dostępne są w 5 kolorach - czarny, biały, chrom (srebrny) złoty i patyna (stare złoto). Gniazda występują w dwóch kolorach - czarny i biały.





ROUND SERIES

LINIA ROUND



Single switch

- Single switch universal (1-gang 1-way or 1-gang 2-ways)
- Crossbar switch
- Single press switch (doorbell)
- Dimmer

Włącznik pojedynczy

- Uniwersalny (schodowy)
- Krzyżowy
- Dzwonkowy (monostabilny)
- Ściemniacz



Double switch:

- Double switch (2-gang 1-way)
- Double stair switch (2-gang 2-way)
- Double crossbar switch
- Double press switch
- Shutter switch

Włącznik podwójny

- Świecznikowy (seryjny)
- Podwójny schodowy
- Roletowy
- Podwójny dzwonkowy (monostabilny)



Outlets:

- Outlet with pin 2P + PE with safety shutters
- Outlet SHUKO with safety shutters
- British standard outlet

Gniazdo

- Gniazdo 2P+Z
- Schuko
- Brytyjskie

MULTIPLE FRAMES EXAMPLES



ROUND SERIES - DIMENSIONS

LINIA ROUND - WYMIARY

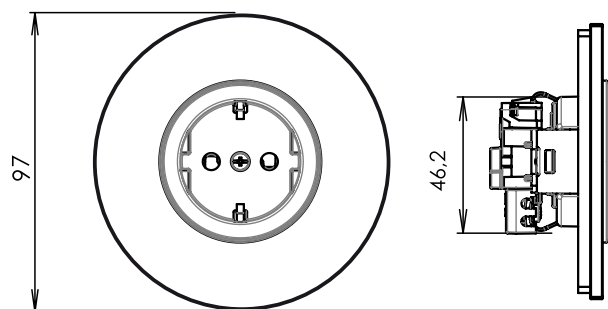
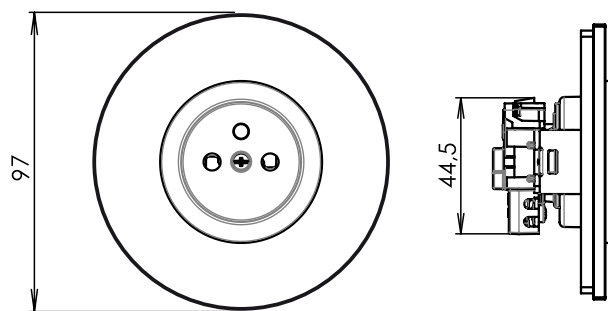
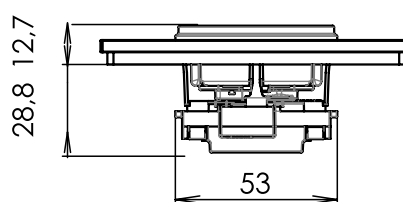
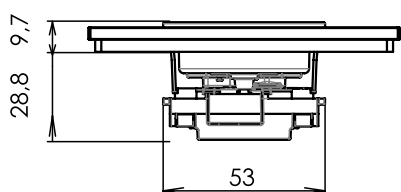
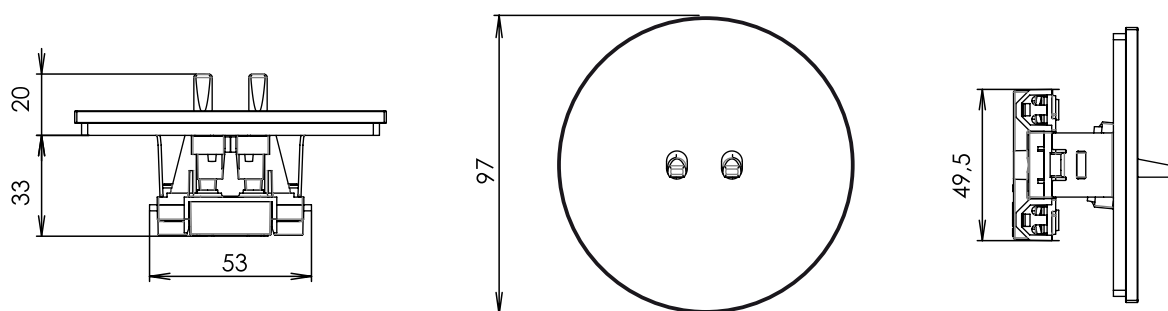
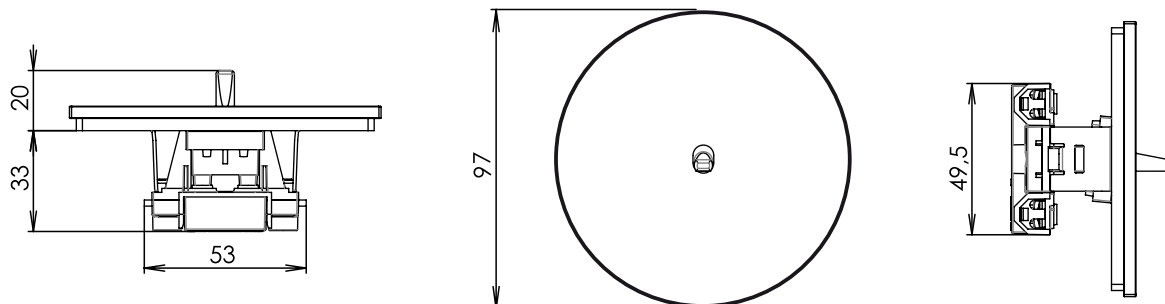



Examples of colours combination



SQUARE SERIES

LINIA SQUARE



Single switch

- Single switch universal (1-gang 1-way or 1-gang 2-ways)
- Crossbar switch
- Single press switch (doorbell)
- Dimmer

Włącznik pojedynczy

- Uniwersalny (schodowy)
- Krzyżowy
- Dzwonkowy (monostabilny)
- Ściemniacz



Double switch:

- Double switch (2-gang 1-way)
- Double stair switch (2-gang 2-way)
- Double crossbar switch
- Double press switch
- Shutter switch

Włącznik podwójny

- Świecznikowy (seryjny)
- Podwójny schodowy
- Roletowy
- Podwójny dzwonkowy (monostabilny)



Outlets:

- Outlet with pin 2P + PE with safety shutters
- Outlet SHUKO with safety shutters
- British standard outlet

Gniazdo

- Gniazdo 2P+Z
- Schuko
- Brytyjskie

MULTIPLE FRAMES EXAMPLES



SQUARE SERIES - DIMENSIONS

LINIA SQUARE - WYMIARY

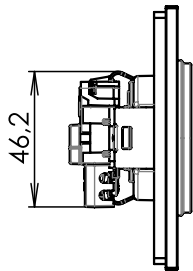
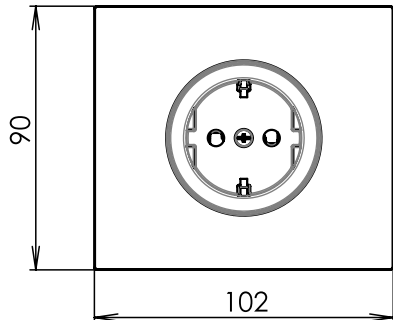
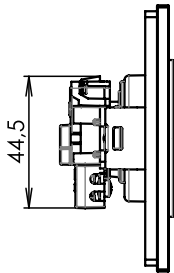
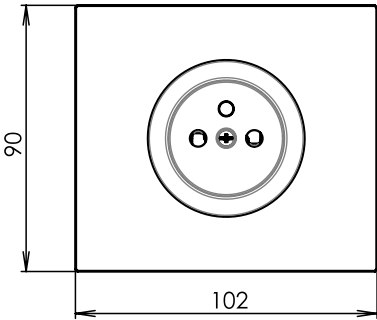
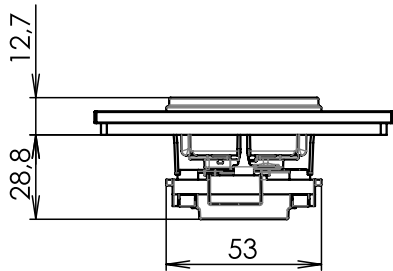
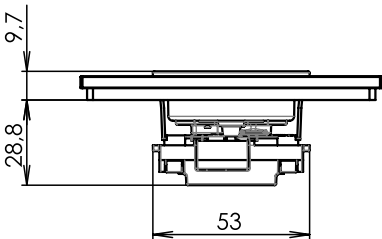
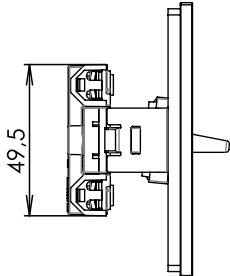
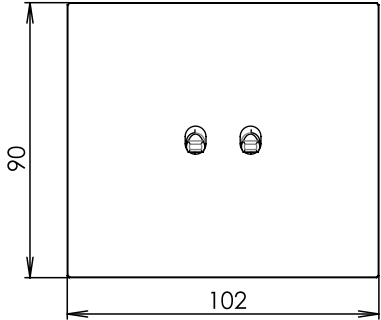
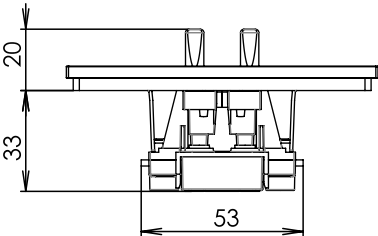
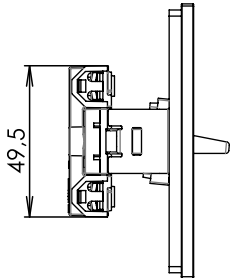
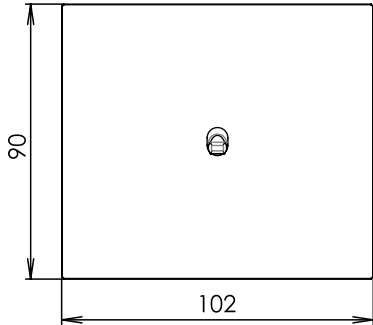
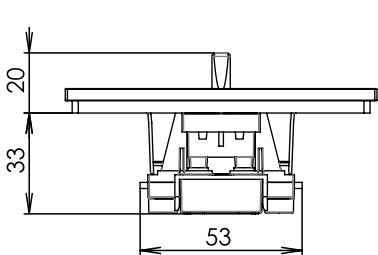



Examples of colours combination



FULL RANGE OF MECHANISM

PEŁNA GAMA MECHANIZMÓW



COLOURS



WHITE - RAL 9016
FINE TEXTURE

BIAŁY - DROBNA STRUKTURA



BLACK - RAL 9005
FINE TEXTURE

CZARNY - DROBNA STRUKTURA



BRUSHED GOLD

SZCZOTKOWANE ŻŁOTO



BRUSHED ALUMINIUM

SZCZOTKOWANE ALUMINIUM



BRUSHED TITANIUM

SZCZOTKOWANY TYTAN



OLD GOLD

STARE ŻŁOTO

Other colours of frames from the RAL or NCS palette, are available on request.

Inne kolory ramek z palety RAL lub NCS, są dostępne na zapytanie.

Due to the catalog printing technology, the colours in the photos may vary from the colours of the painted products.

Z uwagi na technologię druku katalogu, kolory na zdjęciach mogą różnić się od kolorów malowanych produktów.



free your mind
with our plentiful
colour palette



Examples of configurations (Frame multiplicities) / Przykładowe konfiguracje

Double horizontal frames

Ramki podwójne poziome

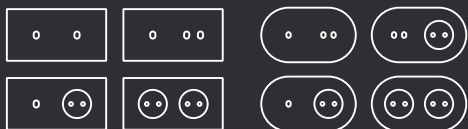

Double vertical frames

Ramki podwójne pionowe

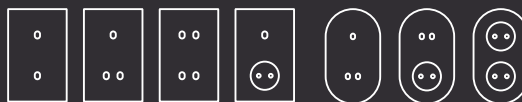

Triple horizontal frames

Ramki potrójne poziome

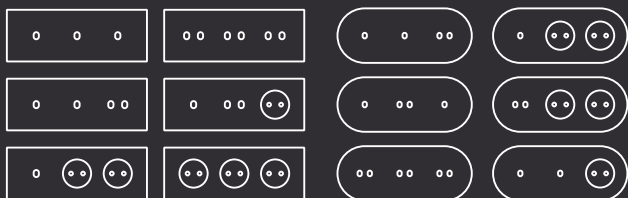

Triple vertical frames

Ramki potrójne pionowe

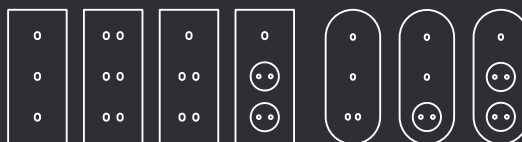

Fourfold horizontal frames

Ramki poczwórne poziome

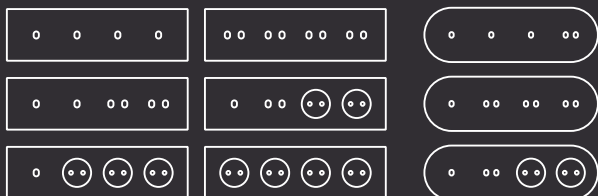

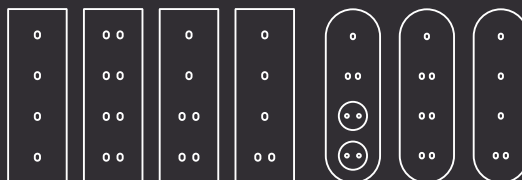

Fourfold vertical frames

Ramki poczwórne pionowe

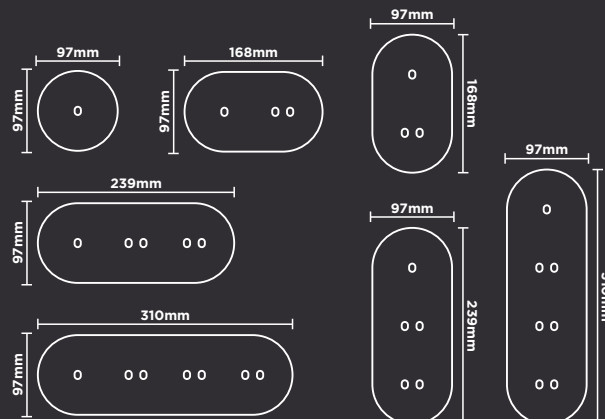
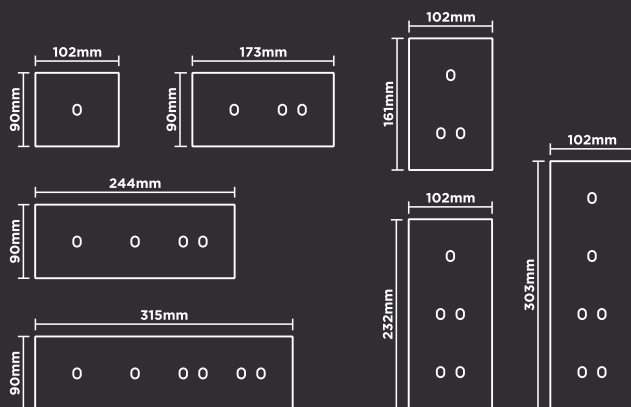

Dimensions / Wymiary





Our own powder paint shop allows us to experiment and meet customer expectations that go beyond standard proposals.

Posiadając własną malarnię proszkową możemy eksperymentować z kolorem, strukturą i wykończeniem ramek. Dzięki temu jesteśmy w stanie zaproponować klientom rozwiązania wychodzące daleko poza standard.

vectis



PRODUCER
PRODUCENT



www.isdvectis.pl

 facebook | vectisswitch

 instagram | vectis_switch